

Varenummer: 201341V40V402SW

Beskrivelse: E+G Rørholder - GN 134.1-V40-V40-2-SW

Mål

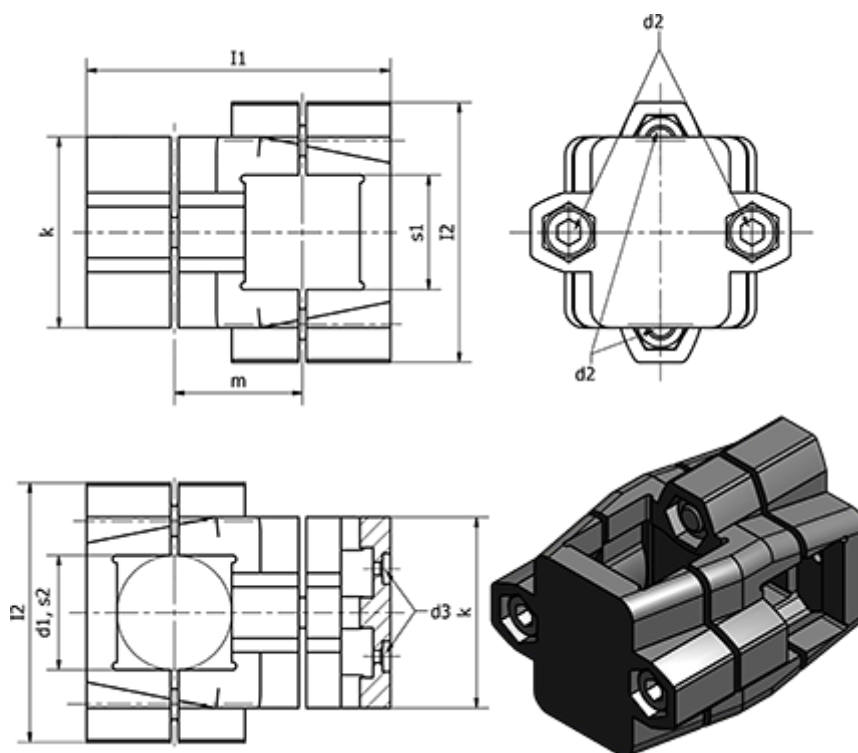

d1	= -	m	= 55
d2	= M10	s1	= V40
d3	= M5	s2	= V40
Fastspændings kit for d2	= -	Vægt (g)	= 946
Fastspændings kit for d2	= GN 911-M10-55		
l1	= 125		
l2	= 98		
k	= 76		